

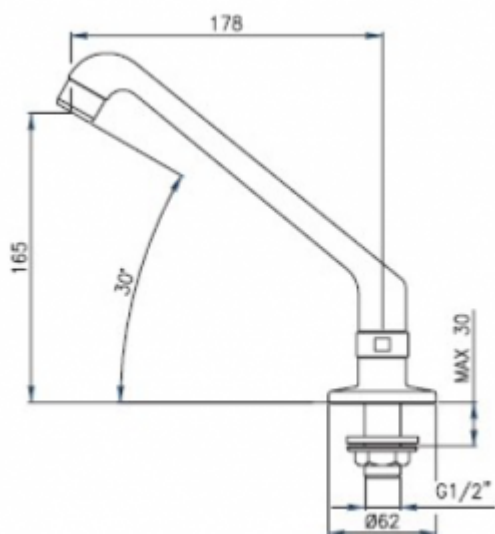

washbasin spout 2015

- The body is made of chrome-plated brass
- High resistance to vandalism
- Exceptional durability and reliability
- Aerator
- Italian product
- Simple operation
- Easy assembly

Connector	G1/2
Design	Chrome-plated brass
Water pressure reductor	up to 21 l/min.
Water temperature	5-65°C
Water pressure	Min 0,5 bar - Max 6 bar (Recommended 2-4 bar)



Riser-type washbasin spout with one G1 / 2 connection. The spout's body is made of brass with a layer of chrome. An aerator has been installed at the point of water outflow. The maximum water outflow force may be 21 l / m at a pressure of 3 bar.

The water connection temperature can be between 5 ° C and 65 ° C. On the other hand, the water connection pressure can range from 0.5 - 6 bar, while the recommended connection pressure should be 2-4 bar.